

Surface Mount Schottky Barrier Rectifier


SMC (DO-214AB)

RoHS
 COMPLIANT
HALOGEN
FREE
 Available

FEATURES

- Low profile package
- Ideal for automated placement
- Guardring for overvoltage protection
- Low power losses, high efficiency
- Low forward voltage drop
- High surge capability
- Meets MSL level 1, per J-STD-020, LF maximum peak of 260 °C
- AEC-Q101 qualified available
 - Automotive ordering code: base P/NHE3 or P/NHM3
- Material categorization: for definitions of compliance please see www.vishay.com/doc?99912

TYPICAL APPLICATIONS

For use in low voltage high frequency inverters, freewheeling, DC/DC converters, and polarity protection applications.

MECHANICAL DATA

Case: SMC (DO-214AB)

Molding compound meets UL 94 V-0 flammability rating

Base P/N-E3 - RoHS-compliant, commercial grade

Base P/N-M3 - halogen-free, RoHS-compliant, commercial grade

Base P/NHE3_X - RoHS-compliant and AEC-Q101 qualified

Base P/NHM3_X - halogen-free, RoHS-compliant, and

AEC-Q101 qualified

("_X" denotes revision code e.g. A, B,)

Terminals: matte tin plated leads, solderable per J-STD-002 and JESD 22-B102

E3, M3, HE3, and HM3 suffix meets JESD 201 class 2 whisker test

Polarity: color band denotes the cathode end

PRIMARY CHARACTERISTICS	
$I_{F(AV)}$	3.0 A
V_{RRM}	20 V, 30 V, 40 V, 50 V, 60 V
I_{FSM}	100 A
EAS	20 mJ
V_F	0.5 V, 0.75 V
T_J max.	150 °C
Package	SMC (DO-214AB)
Circuit configuration	Single

MAXIMUM RATINGS ($T_A = 25\text{ °C}$ unless otherwise noted)								
PARAMETER	SYMBOL	SS32	SS33	SS34	SS35	SS36	UNIT	
Device marking code		S2	S3	S4	S5	S6		
Maximum repetitive peak reverse voltage	V_{RRM}	20	30	40	50	60	V	
Maximum RMS voltage	V_{RMS}	14	21	28	35	42	V	
Maximum DC blocking voltage	V_{DC}	20	30	40	50	60	V	
Maximum average forward rectified current at T_L (fig. 1)	$I_{F(AV)}$	3.0						A
Peak forward surge current 8.3 ms single half sine-wave superimposed on rated load	I_{FSM}	100						A
Non-repetitive avalanche energy at $T_A = 25\text{ °C}$, $I_{AS} = 2.0\text{ A}$, $L = 10\text{ mH}$	E_{AS}	20						mJ
Voltage rate of change (rated V_R)	dV/dt	10 000						V/ μ s
Operating junction temperature range	T_J	-55 to +150						°C
Storage temperature range	T_{STG}	-55 to +150						°C

ELECTRICAL CHARACTERISTICS ($T_A = 25\text{ }^\circ\text{C}$ unless otherwise noted)									
PARAMETER	TEST CONDITIONS	SYMBOL	SS32	SS33	SS34	SS35	SS36	UNIT	
Maximum instantaneous forward voltage ⁽¹⁾	3.0 A	V_F	0.5			0.75		V	
Maximum DC reverse current at rated DC blocking voltage ⁽¹⁾	$T_A = 25\text{ }^\circ\text{C}$	I_R	0.5						mA
	$T_A = 100\text{ }^\circ\text{C}$		20			10			

Note
⁽¹⁾ Pulse test: 300 μs pulse width, 1 % duty cycle

THERMAL CHARACTERISTICS ($T_A = 25\text{ }^\circ\text{C}$ unless otherwise noted)								
PARAMETER	SYMBOL	SS32	SS33	SS34	SS35	SS36	UNIT	
Typical thermal resistance ⁽¹⁾	$R_{\theta JA}$	55						$^\circ\text{C/W}$
	$R_{\theta JL}$	17						

Note
⁽¹⁾ PCB mounted with 0.55" x 0.55" (14 mm x 14 mm) copper pad areas

ORDERING INFORMATION (Example)				
PREFERRED P/N	UNIT WEIGHT (g)	PREFERRED PACKAGE CODE	BASE QUANTITY	DELIVERY MODE
SS36-E3/57T	0.235	57T	850	7" diameter plastic tape and reel
SS36-E3/9AT	0.235	9AT	3500	13" diameter plastic tape and reel
SS36HE3_B/H ⁽¹⁾	0.235	H	850	7" diameter plastic tape and reel
SS36HE3_B/I ⁽¹⁾	0.235	I	3500	13" diameter plastic tape and reel
SS36-M3/57T	0.235	57T	850	7" diameter plastic tape and reel
SS36-M3/9AT	0.235	9AT	3500	13" diameter plastic tape and reel
SS36HM3_A/H ⁽¹⁾	0.235	H	850	7" diameter plastic tape and reel
SS36HM3_A/I ⁽¹⁾	0.235	I	3500	13" diameter plastic tape and reel

Note
⁽¹⁾ AEC-Q101 qualified

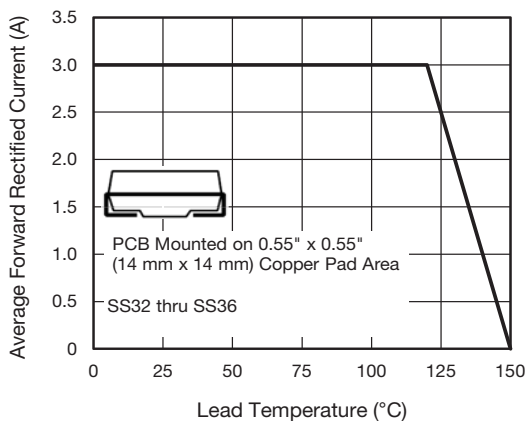
RATINGS AND CHARACTERISTICS CURVES ($T_A = 25\text{ }^\circ\text{C}$ unless otherwise noted)


Fig. 1 - Forward Current Derating Curve

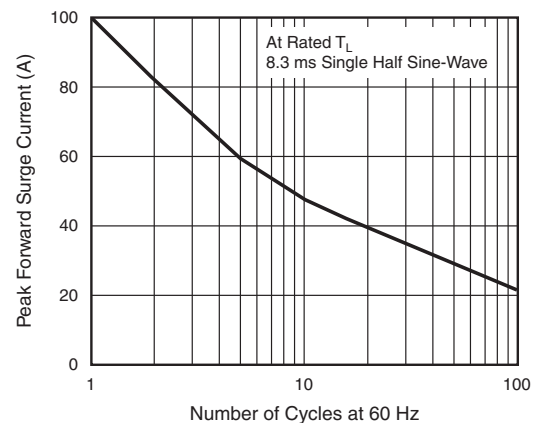


Fig. 2 - Maximum Non-Repetitive Peak Forward Surge Current

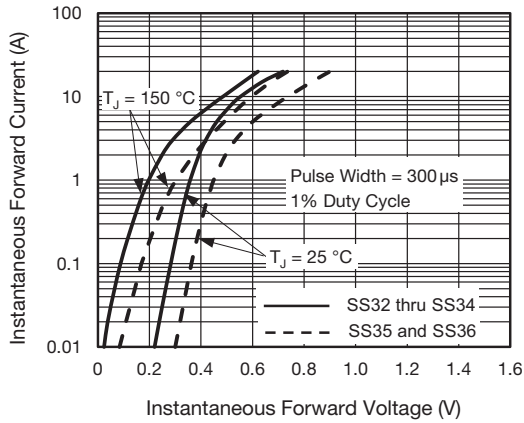


Fig. 3 - Typical Instantaneous Forward Characteristics

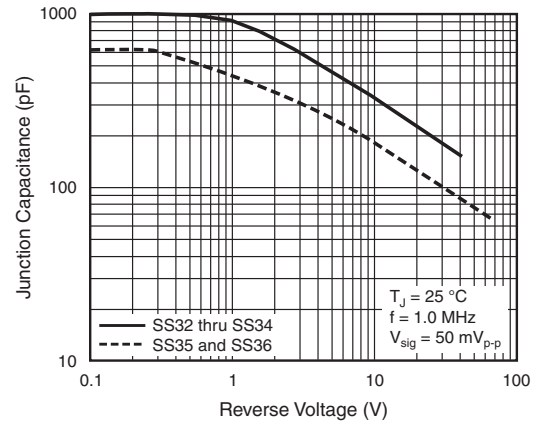


Fig. 5 - Typical Junction Capacitance

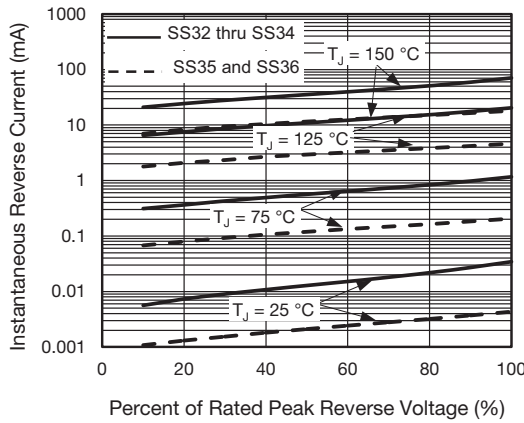


Fig. 4 - Typical Reverse Current Characteristics

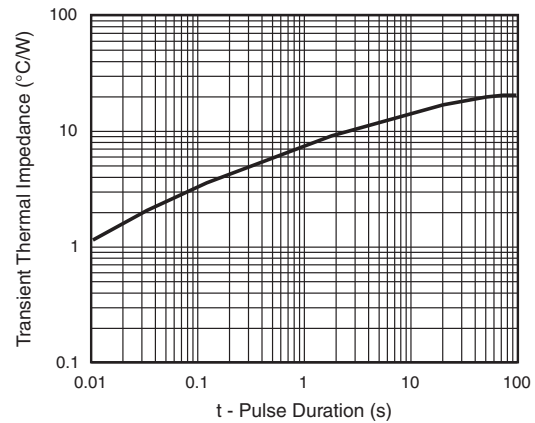
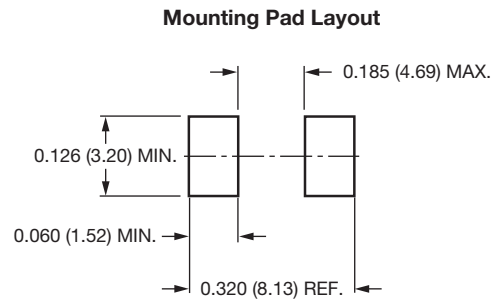
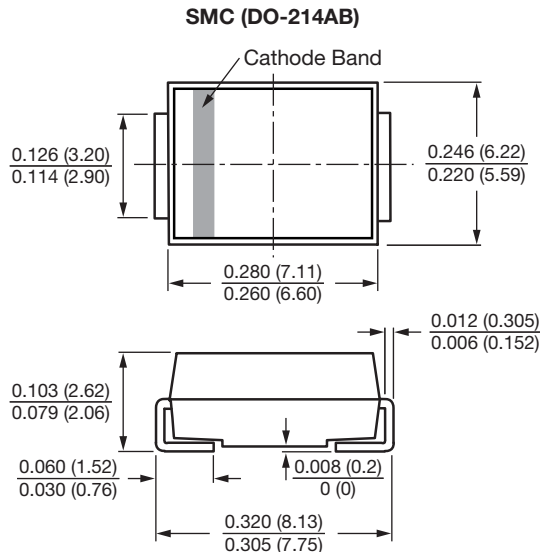


Fig. 6 - Typical Transient Thermal Impedance

PACKAGE OUTLINE DIMENSIONS in inches (millimeters)





Disclaimer

ALL PRODUCT, PRODUCT SPECIFICATIONS AND DATA ARE SUBJECT TO CHANGE WITHOUT NOTICE TO IMPROVE RELIABILITY, FUNCTION OR DESIGN OR OTHERWISE.

Vishay Intertechnology, Inc., its affiliates, agents, and employees, and all persons acting on its or their behalf (collectively, "Vishay"), disclaim any and all liability for any errors, inaccuracies or incompleteness contained in any datasheet or in any other disclosure relating to any product.

Vishay makes no warranty, representation or guarantee regarding the suitability of the products for any particular purpose or the continuing production of any product. To the maximum extent permitted by applicable law, Vishay disclaims (i) any and all liability arising out of the application or use of any product, (ii) any and all liability, including without limitation special, consequential or incidental damages, and (iii) any and all implied warranties, including warranties of fitness for particular purpose, non-infringement and merchantability.

Statements regarding the suitability of products for certain types of applications are based on Vishay's knowledge of typical requirements that are often placed on Vishay products in generic applications. Such statements are not binding statements about the suitability of products for a particular application. It is the customer's responsibility to validate that a particular product with the properties described in the product specification is suitable for use in a particular application. Parameters provided in datasheets and / or specifications may vary in different applications and performance may vary over time. All operating parameters, including typical parameters, must be validated for each customer application by the customer's technical experts. Product specifications do not expand or otherwise modify Vishay's terms and conditions of purchase, including but not limited to the warranty expressed therein.

Except as expressly indicated in writing, Vishay products are not designed for use in medical, life-saving, or life-sustaining applications or for any other application in which the failure of the Vishay product could result in personal injury or death. Customers using or selling Vishay products not expressly indicated for use in such applications do so at their own risk. Please contact authorized Vishay personnel to obtain written terms and conditions regarding products designed for such applications.

No license, express or implied, by estoppel or otherwise, to any intellectual property rights is granted by this document or by any conduct of Vishay. Product names and markings noted herein may be trademarks of their respective owners.